

Getting started with your SmartRooms Comfort Controller is as easy as ... 1,2,3.

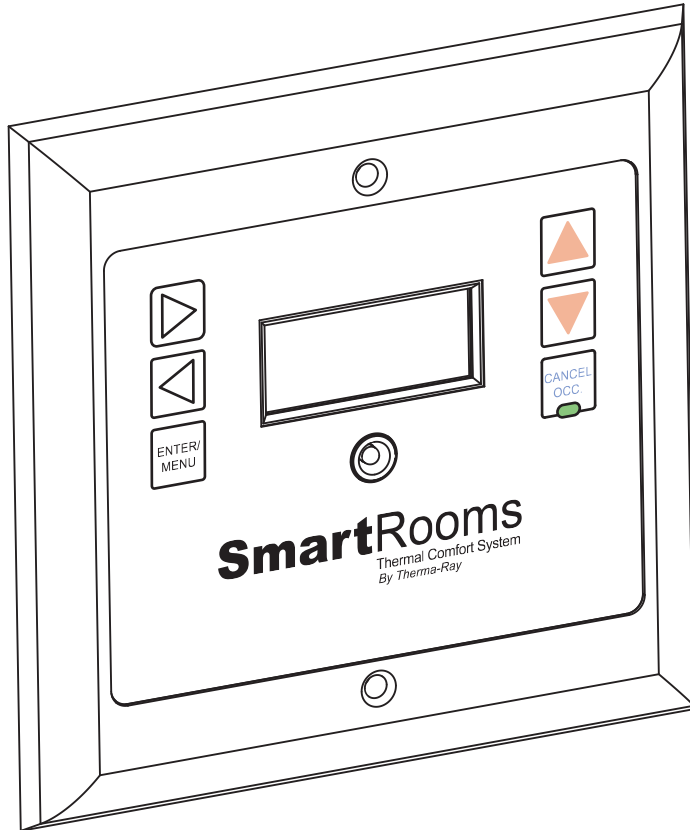

1

Press **Cancel/Occ.** to put Comfort Controller in manual mode

2

Verify that the green light is on indicating manual mode.

3

Choose the desired room temperature using the **Up** or **Down** arrows. Then press **Enter/Menu** to save the change. You can change this temperature at any time.

Notes:

° Your Low Voltage Comfort Controller must be connected to the SmartRooms Distribution Panel (SRDP) in order for the heating system to function.

⏴ ° Your Floor or Earth Storage System is calling for heat when a **Down** arrow is displayed.

⏵ ° Your Ceiling System is calling for heat when an **Up** arrow is displayed.

⏶ ° Your Floor and Ceiling Systems are calling for heat when a **Both** arrow is displayed..

° Your System will turn ON when the temperature difference between the Comfort Settings and the actual floor temperature is more than 2° Fahrenheit (1° Celsius).

SmartRooms
Thermal Comfort System
By Thermo-Ray

APPLIES TO MODELS SR-LV & SR-LV-B

SmartRooms

Thermal Comfort System

By Therma-Ray

Whether you're a contractor, architect, builder or homeowner, creating the perfect indoor environment has always been a challenge. Therma-Ray, the world's #1 name in thermal comfort systems, introduces you to the ultimate solution: SmartRooms. Please take the time to read this operation guide carefully before you begin. A diagram of the menu display system is found at the end of this guide for easy reference.

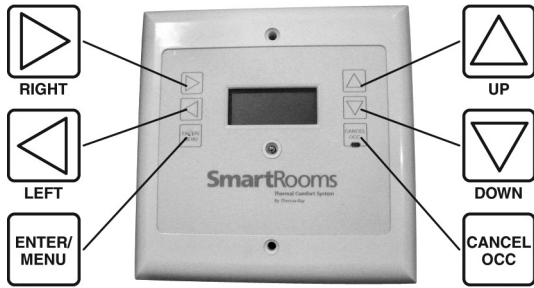

COMFORT CONTROLLER LOW VOLTAGE (SR-LV & SR-LV-B) Owners Manual

SmartRooms Comfort Controller displays the current time and room temperature. It also displays the day of the week and the given temperature set point. It is programmable and operational in both English and French. See the Secondary Features section on Page '3/6' to set language preference.

Set Date			Set Time		
Press		Display	Press		Display
1. [ENTER/MENU]	→	MENU DATE	1. [ENTER/MENU]	→	MENU DATE
2. [ENTER/MENU]	→	MM/DD/YY 03/01/03	2. [DOWN]	→	MENU TIME
3. [LEFT] [RIGHT]	Select MM, DD or YY	MM/DD/YY 03/01/03	3. [ENTER/MENU]	→	HH:MM 10:32AM
4. [UP] [DOWN]	Set Numbers	MM/DD/YY 03/07/03	4. [LEFT] [RIGHT]	Select HH or MM	HH:MM 10:32AM
5. [ENTER/MENU]	→	MENU DATE	5. [UP] [DOWN]	Set Numbers	HH:MM 10:45AM
6. [CANCEL OCC.]	→	10:30AM 23.3C	6. [ENTER/MENU]	→	MENU TIME
			7. [CANCEL OCC.]	→	10:45AM 23.3C

Set Mode

This option needs to be set as it allows you to input which system (Floor, Ceiling or ETS) or systems are being controlled by this particular controller.

BOTH - Ceiling and Floor Systems

ES + DHW - Earth Storage and Domestic Hot Water

FLOOR - Floor System Only

Ceiling - Ceiling System Only

Press	Display
1.	MENU DATE
2. x3	MENU SETUP
3.	SETUP TIME FMT
4.	SETUP MODE
5.	MODE BOTH
6. → Set Mode Ex. 'Floor'	MODE FLOOR
7.	MODE UPDATED
8. x3	10:30AM 23.3C

Set Temp Scale

Press	Display
1.	MENU DATE
2. x 3	MENU SETUP
3.	SETUP TIME FMT
4. x 2	SETUP SCALE ?
5.	SCALE ? CENTI

Set Temp Scale (Cont'd)

Press	Display
6.	SCALE ? FAHREN
7.	SCALE ? UPDATED
8. x2	22:30 70°F

Set Daily Programs

Use this function to program your temperature set points for each day of the week. The controller accepts up to five set points per day, the first starting at 12:00am, the last finishing at 11:59pm.

For Earth Storage - If your utility does not have the capability of remotely turning off the power to your ETS system, we suggest that you set your programs to turn off 10 minutes before peak rates come into effect. This should avoid the ETS system from being on during peak hours due to clock misalignments.

Press	Display
1.	MENU DATE
2. x 5	MENU SCHEDULE
3.	WEEKDAY SUNDAY
4.	MENU PROG 01
5.	ALWAYS START 12:00AM
6.	ENDS AT: 06:00 PM
7. → Select HH or MM	ENDS AT: 06:00 PM
8. → Set End Time	ENDS AT: 08:00 AM
9.	FLOOR 20.0 C

Set Daily Programs (Cont'd)

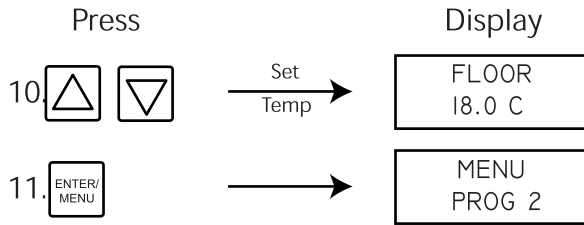

Repeat steps 5-10 until you reach program 5 or until you reach 11:59PM.

To copy all the programs from Sunday to the rest of the six remaining days:

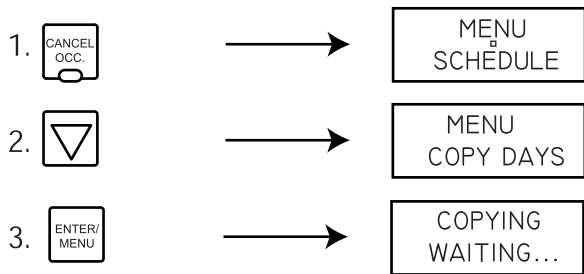

Set Daily Programs (Cont'd)

Note: "Copy Days" saves you programming time. If you prefer your weekdays programmed differently from the weekend, program Sunday as if it were Monday. Use "Copy Days" to make all days the same then return to step 4 and modify the weekend program.

Ready to Operate

After setting all of your day's programs your SmartRooms Comfort Controller is ready to start operating on its own. If at any time you wish to override your day program temperature settings, you can easily press the **Cancel/Occ** button to activate the Occupied Temperature Override. The light below the button will be on when the override is activated. Pressing the **Cancel/Occ** button again will reactivate the regular schedules. Should you forget to cancel the override, the SmartRooms Comfort Controller will remain in Manual Mode - your programmed schedule will not become activated. The occupied temperature setting can also be easily changed by pressing the **Up** and **Down** arrows when your time, date and temperature are being displayed.







Use this chart to keep track of your preferred program schedules. Enter the program end-time and desired temperature in each of the given boxes.

Day	Prog1 time	Prog1 temp	Prog2 time	Prog2 temp	Prog3 time	Prog3 temp	Prog4 time	Prog4 temp	Prog5 time	Prog5 temp
Sun										
Mon										
Tue										
Wed										
Thu										
Fri										
Sat										







Secondary Features

Set Occupied Temp









Use this function to set the default room temperature when you choose to override your daily programs. To override the daily programs, press the Occupied button to set the controller in manual mode (Green LED on).

Press	Display
1. 	MENU DATE
2.  x 2	MENU OCCUPIED
3. 	MENU 25°C
4.   → Set Temp	MENU 20°C
5. 	MENU UPDATED.
6. 	10:30AM 23.3C

Set Language









Press	Display
1. 	MENU DATE
2.  x 2	MENU LANGUAGE
3. 	LANGUAGE ENGLISH
4.   → Set Language	LANGUAGE FRANCAIS
5. 	LANGUAGE UPDATED...
6. 	10:30AM 23.3 C

Set Time Format

Press	Display
1. 	MENU DATE
2.  x 3	MENU SETUP
3. 	SETUP TIME FMT
4. 	TIME FMT AM/PM
5.   → Set Format	TIME FMT 24 HR
6. 	TIME FMT UPDATED...
7.  x 3	10:30AM 23.3C

Set Vacation Temp

Use this function to program the temperature set point used by the vacation function.

Press	Display
1. 	MENU DATE
2.  x 3	MENU SETUP
3. 	SETUP TIME FMT
4.  x 4	SETUP VAC TEMP
5. 	VAC TEMP 41.0°F
6.   → Set Vac Temp	VAC TEMP 35.5°F
7. 	VAC TEMP UPDATED...
8.  x 2	22:30 35.5°F

Secondary Features (Continued)

Activate Vacation Temp

Use this function to override your programs. This function is especially useful when you go on vacation and you want to keep your residence at a constant low temperature to save on energy costs.

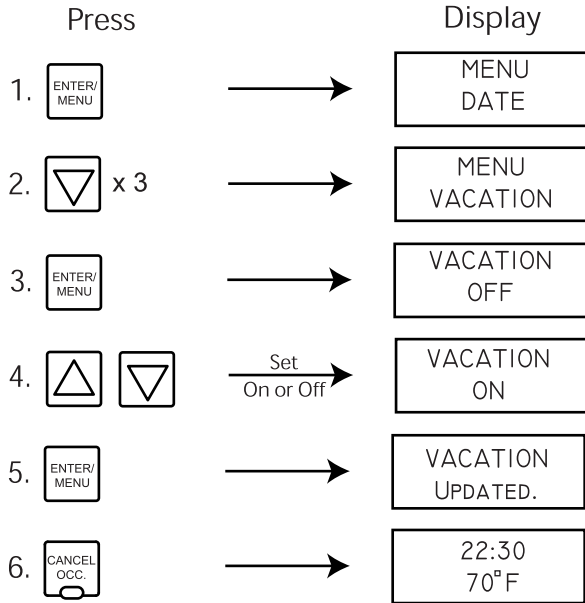

Set Global Option

The Global option copies the following common features to all the controllers connected on the network: Date, Occupied, Vacation, Schedule, Programs, Time, Temp Scale (°C or °F), Daylight Savings (On or Off).

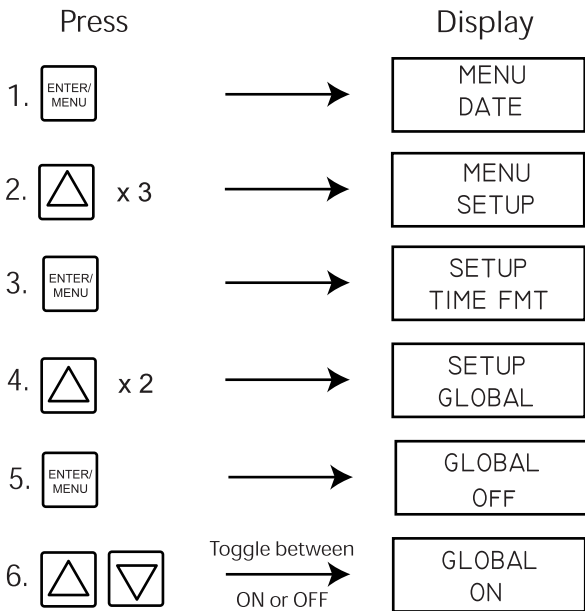

Set Global Option

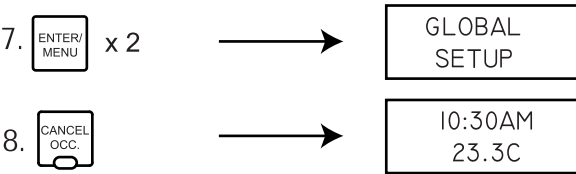

Set Address

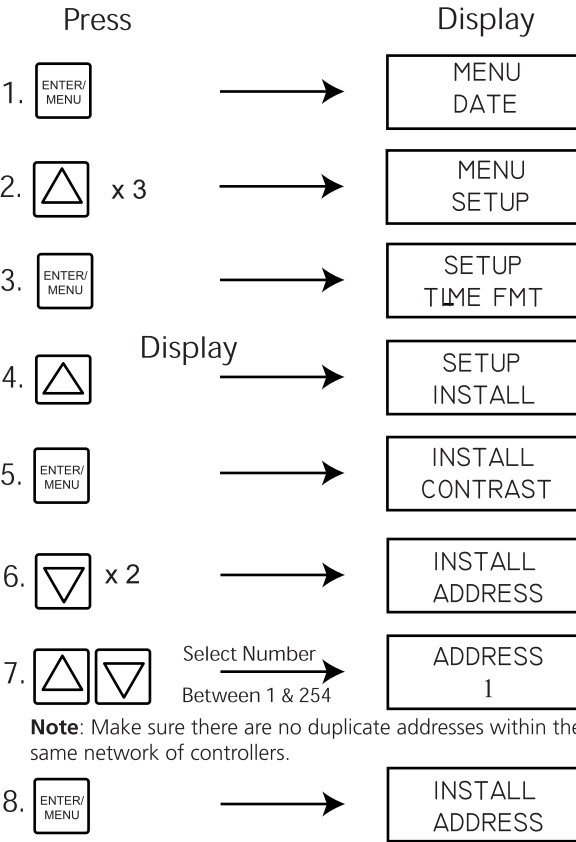





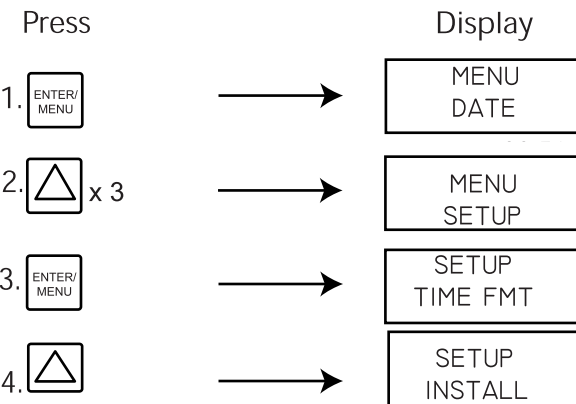







Note: Make sure there are no duplicate addresses within the same network of controllers.

Set Name







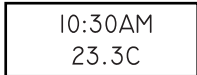











Secondary Features (Continued)

Set Name (Cont'd)



- | Press | | Display |
|--|-------------------------------|---|
| 5.  | → |  |
| 6.  x 3 | → |  |
| 7.   | Select Unique Room Name → |  |
| 8.   | Select Letter Between A & Z → |  |
| Note: Extra '?' symbols will disappear once 'Enter' is pressed. | | |
| 9.  | → |  |
| 10.  x 2 | → |  |

Set Daylight Savings Time

This function is factory set to ON. If your area does not use daylight savings time, set to OFF.

- | Press | | Display |
|--|--------------------|---|
| 1.  | → |  |
| 2.  x 3 | → |  |
| 3.  | → |  |
| 4.  | → |  |
| 5.  | → |  |
| 6.  x 2 | → |  |
| 7.  | → |  |
| 8.  | Set Daylight OFF → |  |

Set Daylight Savings Time (cont'd)

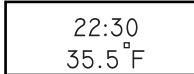
- | Press | | Display |
|---|---|---|
| 9.  | → |  |
| 10.  x 3 | → |  |

Lockout Option

For future release

Multiple Sources Options

Testing / Viewing Current Temperature Readings From Available Sources - To test / view the currently read temperatures from both the ceiling and the floor sensors, go to the **Menu** screen, select **Setup** from the options, then scroll to the **Sensors** option. Select the option, press **Enter/Menu** and with the "Up and Down" arrows, you can choose which sensor for which you wish to view the reading. Once you are done, press the **Cancel/Occ** button until you have returned to the "Time/Date/Temperature" display screen.

High Limit Temperature - Do not change this feature. It is used for ETS, Ceiling and other special applications.

Selecting The Appropriate Sensor - You can set the SmartRooms Controller to measure temperatures from either the Floor sensor, Ceiling (onboard sensor) or both. To toggle between these three options, go into the **Menu** screen and scroll through to the **Mode** option. Press **Enter/Menu** to choose the option and press the "Up and Down" keys to toggle. Press the **Enter/Menu** button again to accept the changes.
Note: If you do not have a floor sensor installed, the controller will see it's not present and be shut off, thus disabling temperature control. The **Both** option is only functional with the Low Voltage System. For use with the Earth Storage System, the floor sensor is the one to use.

Secondary Features (Continued)

Multiple Sources Option (Cont'd)

Connecting To A Remote Controller - If you wish to choose settings for a particular controller connected within the same network from a different controller, you can remote into that particular controller by doing the following: From the **Menu** screen, select the **Setup** submenu and scroll down through to the **Remote** option. You will be prompted to enter it correctly, you may configure it as you would the current controller. However, if the controller for the address you entered is invalid or not found, you will receive a 'No Answer' status message. From this point, please try entering the address again, ensuring you are entering the correct one.

Ground Fault Circuit Interrupter (GFCI) - A separate GFCI breaker is required when using the floor warming system.

Troubleshooting

Use the following information to troubleshoot your comfort controller.

Room T* - This indicates that the floor sensor is not working and could be damaged. No need to worry, your SmartRooms Controller has a back up sensor located in the face plate. Your floor warming system will continue to function normally. You may want to do one of the following:

- A) Remove the face plate and check to see if the sensor is properly connected to the back of the face plate.
- B) Leave everything as is.
- C) Replace the sensor. To do this you will likely have to remove tiles. Caution should be taken not to damage the heating cable.

Garbled Screen - Press 'Menu', if this does not work, unplug the controller, wait a few minutes and plug it in again.

No Answer - This is a remote function error. Check that the thermostat is firmly plugged in.

Heat Continuously On - Check high and low limit settings. They may be reversed:

NAMES CHART
 Example:
ADDRESS 1 = KITCHEN
ADDRESS 2 = OFFICE

Address	Name of Room
1	
2	
3	
4	
5	
6	
7	
8	
9	
10	
11	
12	
13	
14	

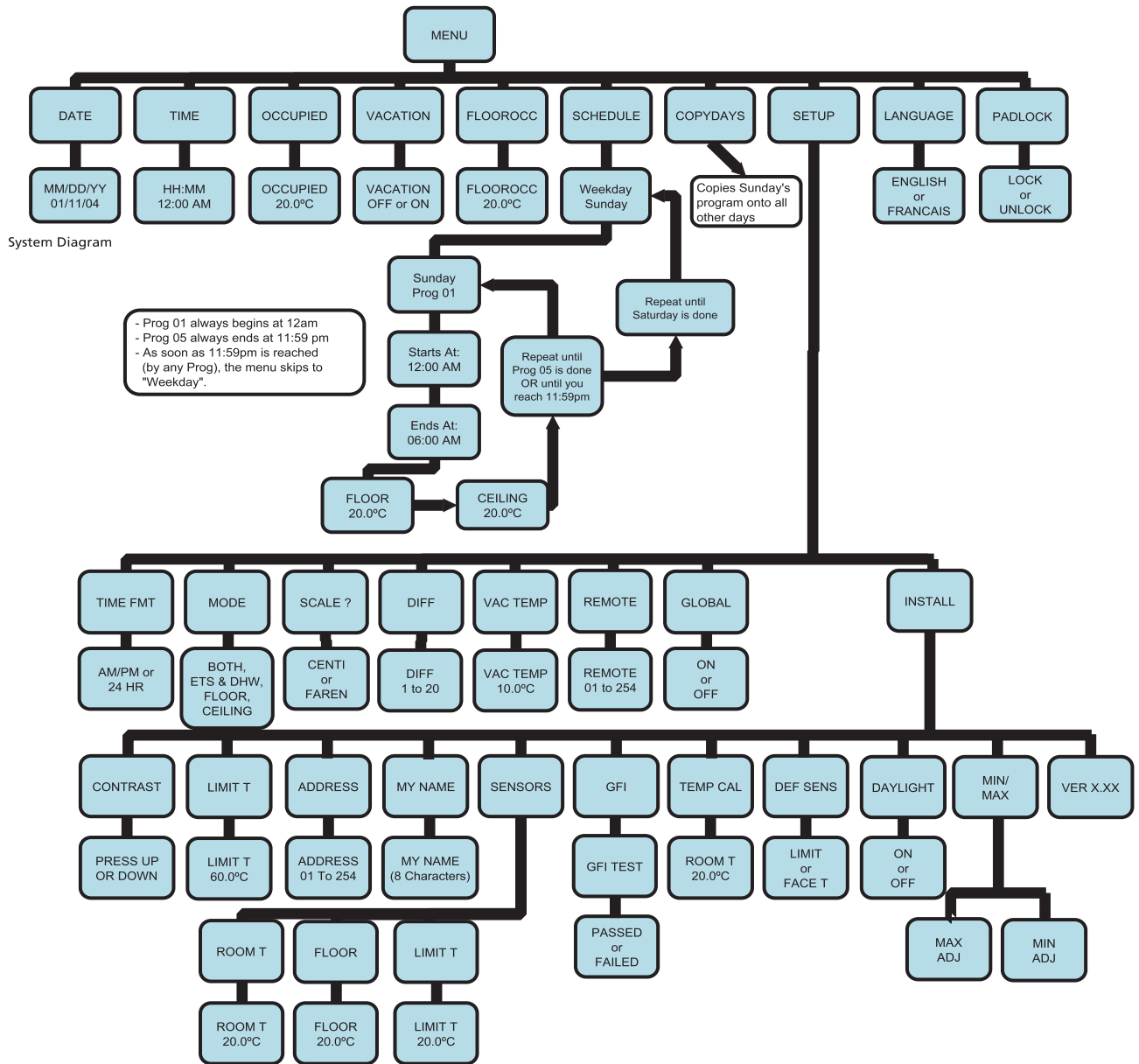

Warranty

Therma-Ray Inc. one (1) Year Limited Warranty. Therma-Ray Inc. warrants the controller is free of defects in material and workmanship after proper installation for a one (1) year period from the date of installation. During this period, Therma-Ray Inc. will replace or repair the controller without charge if it has been used under normal conditions. This warranty does not cover delivery costs. The warranty does not apply if poorly installed or damaged after installation. Therma-Ray Inc. will not compensate for consequential damage, direct or indirect, resulting from the failure of the controller. All other representations, warranties and conditions, whether oral or written, express or implied, statutory or otherwise are expressly excluded. The defective controller must be returned to the place of purchase or sent prepaid to Therma-Ray Inc.

Therma-Ray Inc.

670 Wilsey Road, Fredericton, NB

Canada E3B 7K4

Tel: 866-457-4600 Fax: 506-457-4699

E-mail: sales@thermaray.com

www.thermaray.com

Printed in Canada

SmartRooms

Thermal Comfort System

By Therma-Ray

January 2010

8/8